

## INSTALLATION INSTRUCTIONS FOR OPTIMA SENSOR ACTIVATED LAVATORY FAUCETS WITH THE OPTIMA CONTROL BOX

### DECK MOUNTED OPTIMA FAUCETS



**ETF-600** Low-height, hardwired  
**EBF-650** Low-height, battery

**ETF-610** Low-height, hardwired  
**EBF-615** Low-height, battery

**ETF-660** Low-height, hardwired with side sensor  
**EBF-665** Low-height, battery w/side sensor

**ETF-80** Mid-height, hardwired  
**EBF-85** Mid-height, battery

**ETF-880** Mid-height, hardwired  
**EBF-187** Mid-height, battery

### GOOSENECK DECK MOUNTED OPTIMA FAUCETS



**ETF-770** Hardwired with side sensor  
**EBF-775** Battery with side sensor

**ETF-700** Hardwired  
**EBF-750** Battery

**ETF-700-S** Hardwired with surgical bend  
**EBF-750-S** Battery with surgical bend

### WALL MOUNTED OPTIMA FAUCETS



**ETF-500** Hardwired  
**EBF-550** Battery

**ETF-500-S** Hardwired with surgical bend  
**EBF-550-S** Battery with surgical bend

**ETF-800** Hardwired  
**EBF-850** Battery

### CONTROL BOX FOR ALL FAUCETS



**Control Box w/o Turbine**  
**EFP-39-A**



**Control Box w/ 0.5 gpm Turbine**  
**EFP-40-A**



**Control Box w/1.5 gpm Turbine**  
**EFP-11-A**

### TABLE OF CONTENTS

• Prior To Install.....	2.	• Deck Mounted Rough-in .....	4.
• Mixing Valve Installation .....	2.	• Wall Mounted Rough-in.....	5.
• Important .....	2.	• Dimensional Data .....	5.
• Quick Connect Tee.....	2.	• Troubleshooting Instructions .....	7.
• Tools Required.....	2.	• Care and Cleaning Instructions.....	8.

### LIMITED WARRANTY

Unless otherwise noted, Sloan Valve Company warrants this product, manufactured and sold for commercial or industrial uses, to be free from defects in material and workmanship for a period of three (3) years (1 year for SF faucets, special finish and PWT electronics and 30 days on PWT software) from date of first purchase. During this period, Sloan Valve Company will, at its option, repair, replace, or refund the purchase price of any product which fails to conform with this warranty under normal use and service. This shall be the sole and exclusive remedy under this warranty. Products must be returned to Sloan Valve Company, at customer's cost. No claims will be allowed for labor, transportation or other costs. This warranty extends only to persons or organizations who purchase Sloan Valve Company's products directly from Sloan Valve Company for purpose of resale. This warranty does not cover the life of the battery.

**THERE ARE NO WARRANTIES WHICH EXTEND BEYOND THE DESCRIPTION ON THE FACE HEREOF. IN NO EVENT IS SLOAN VALVE COMPANY RESPONSIBLE FOR ANY CONSEQUENTIAL DAMAGES OF ANY MEASURE WHATSOEVER.**

## PRIOR TO INSTALLATION

Prior to installing the Sloan Optima Faucet, install the items listed below. Also, refer to rough-in illustrations on pages 4 and 5.

- Lavatory/sink
- Drain line
- Hot and cold water supply lines or pre-tempered water supply line

## MIXING VALVE

When installing the faucet with a Sloan mixing valve, these Installation Instructions AND the Installation Instructions packaged with the mixing valve **MUST** be followed.

## IMPORTANT

- **ALL PLUMBING SHOULD BE INSTALLED IN ACCORDANCE WITH APPLICABLE CODES AND REGULATIONS.**
- **FLUSH ALL WATER LINES PRIOR TO MAKING CONNECTIONS.**
- **KEEP THREAD SEALANT OUT OF YOUR WATERWAY TO PREVENT COMPONENT PART DAMAGE! DO NOT USE ANY SEALANT ON COMPRESSION FITTINGS.**

## QUICK CONNECT BAK CHEK® FILTER TEE USAGE

A QUICK CONNECT BAK-CHEK® FILTER TEE MUST BE USED WITH EACH INSTALLATION.

When connecting a Sloan Optima Faucet to both hot and cold water supplies, a two inlet Quick Connect Bak-Chek® Filter Tee is provided and required as illustrated. Water temperature can be controlled by adjusting the supply stops. When connecting the faucet to a single line water supply or a pre-tempered water supply, a single inlet Quick Connect Bak-Chek® Filter Tee must be used. A Quick Connect Bak-Chek® Filter Tee must also be used when a Temperature Mixing Valve is included with the faucet.

## TOOLS REQUIRED FOR INSTALLATION

Gather the required tools and parts before starting installation. Additional parts may be required, depending on your installation. Check local codes. Check existing electrical supply.

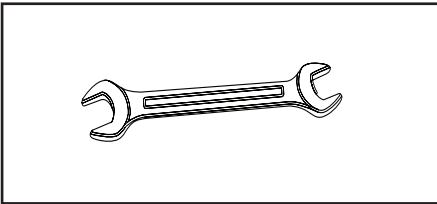

1. Open end wrenches for hex sizes: 1/2", 9/16", 5/8", 15/16"

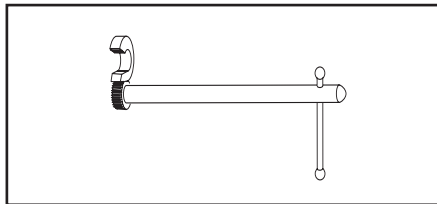

2. Basin wrench

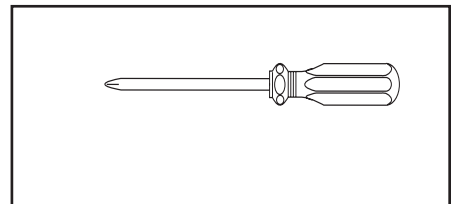

3. Phillips head screwdriver, #2

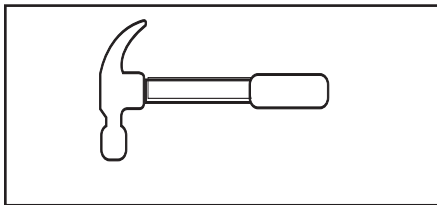

4. Hammer (if installing plastic or hollow wall anchors to mount valve module)

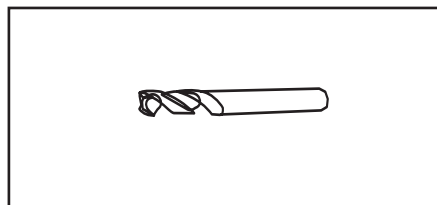

5. 1/4" drill bit (if plastic wall anchors are used to mount valve module)

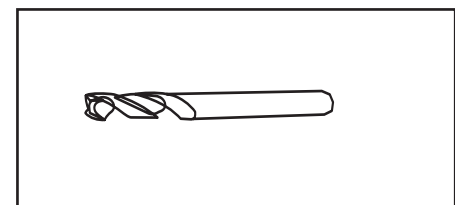

6. 5/16" drill bit (if hollow wall anchors are used to mount valve module)

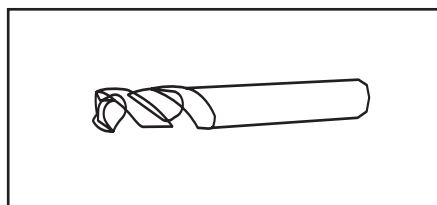

7. 3/8" drill bit (if toggle nut anchors are used to mount valve module)

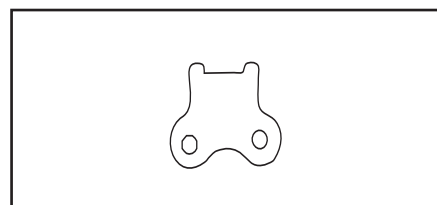

8. Spray head key (supplied with some models)

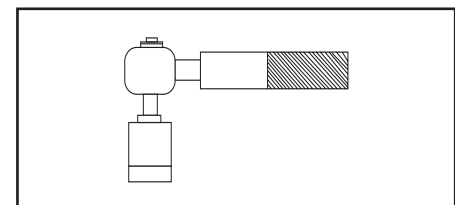

9. 13 mm Socket

## MANIFOLD INSTALLATION

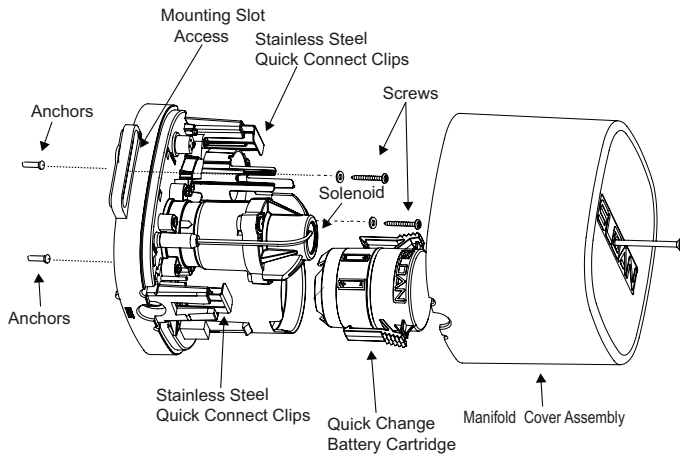

- A.** Ensure there is enough clearance for the flexible supply hose from the spout to connect to the control module
  - B.** Secure control module to wall using the included mounting accessories. The control module must be mounted on a level vertical surface with the Sloan logo on the manifold facing outwards on the top right side of the manifold. Do not mount the manifold in any other position.
  - C.** Insert the flexible supply hose from the bottom of the spout into the top of the mounted manifold. Insert the Filter "T" fitting into the bottom of the mounted manifold. Ensure that the stainless steel clips on both the top and bottom of the manifold are secured.
- NOTE: NEVER OPEN STAINLESS STEEL CLIPS WHEN WATER SUPPLY IS TURNED ON.**

**NOTE: FOR UNITS WITH TURBINES, USE ONLY 0.5GPM / 1.9 LPM CONTROL BOXES WITH SPOUTS RATED FOR THE SAME FLOW AND USE ONLY 1.5 GPM / 5.7 LPM CONTROL BOXES WITH SPOUTS RATED FOR THAT SAME FLOW. DO NOT USE THESE CONTROL BOXES ON ANY OTHER FLOW RATES. CONTROL BOXES WITHOUT TURBINES MAY BE USED WITH ANY SPOUT UP TO 2.2 GPM / 8.3 LPM**

- D.** Connect water supply lines from the stops to the Filter "T" fitting. If a mixing valve is being used, connect water supply lines to the mixing valve. Connect the mixing valve to the single inlet filter tee using the supplied fitting.
- E.** Attach sensor cable and solenoid cable to the appropriate connections on the manifold.
- F.** Insert the battery assembly.
- G.** This unit can use 4 (AA) batteries alone, or accept 6 VDC or 24 VAC power to function as a hardwired unit with battery back up.
- H.** If a 6 VDC plug-in transformer is used, plug it into the appropriate connection on the manifold to convert the faucet into a "plug-in with battery back-up".
- I.** If 24 VAC hardwires are being used, use the supplied adapter piece to connect the wires to the appropriate connection on the manifold.
- J.** If the unit contains an optional turbine, connect the plug from the turbine assembly into the appropriate connection on the manifold.
- K.** If ganging multiple units in a "daisy chain" configuration to a single power supply use the SFP35 gang adapter kit.
- L.** Inspect and tighten all connections. Place the manifold cover onto the unit.
- M.** Turn on water.

## BELOW DECK CONFIGURATION

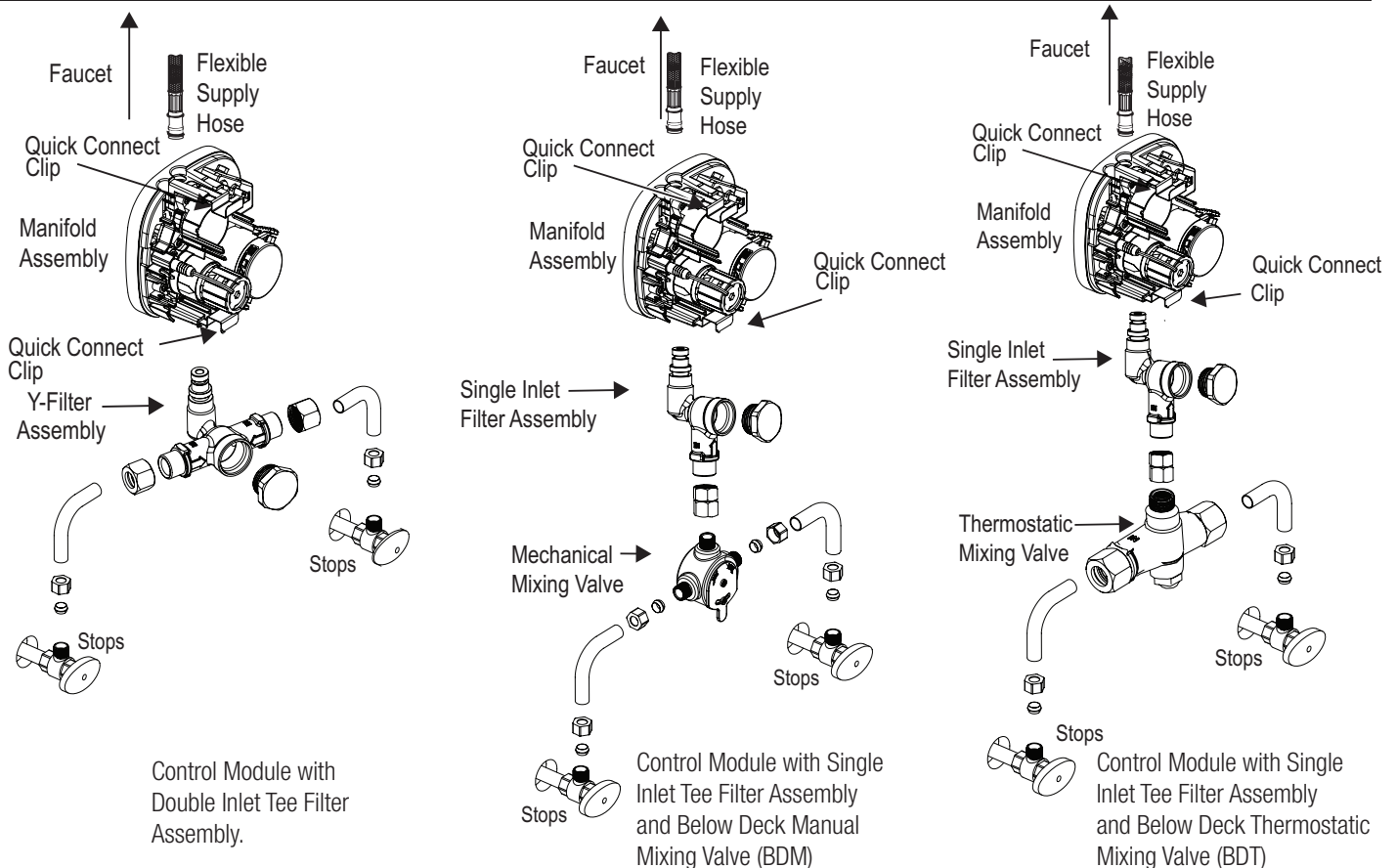

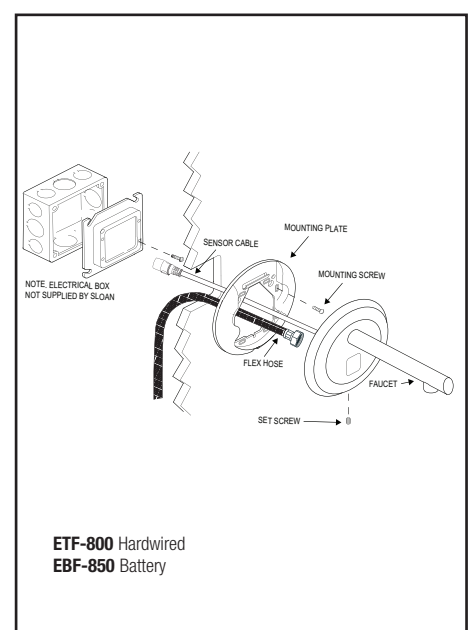
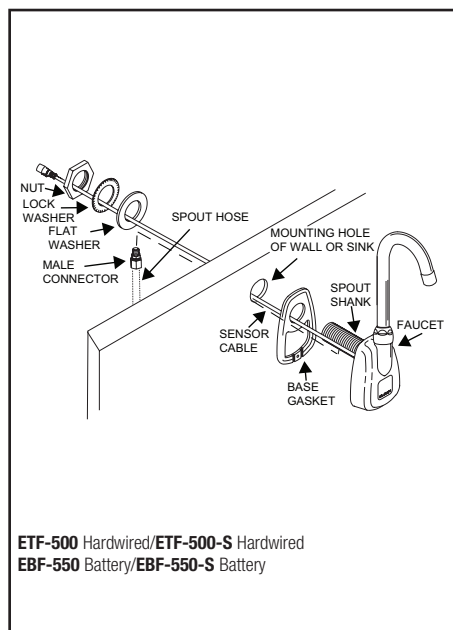
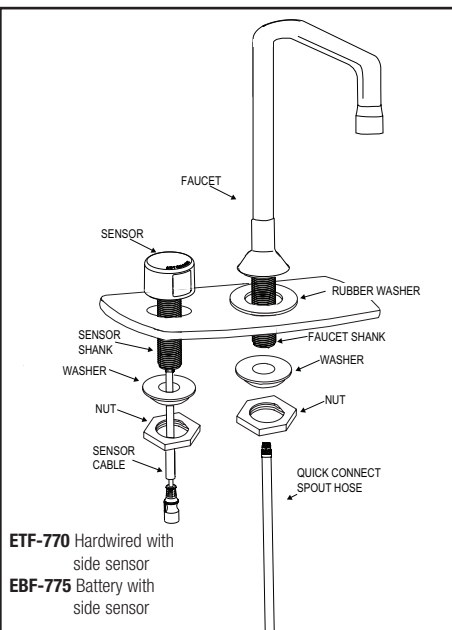
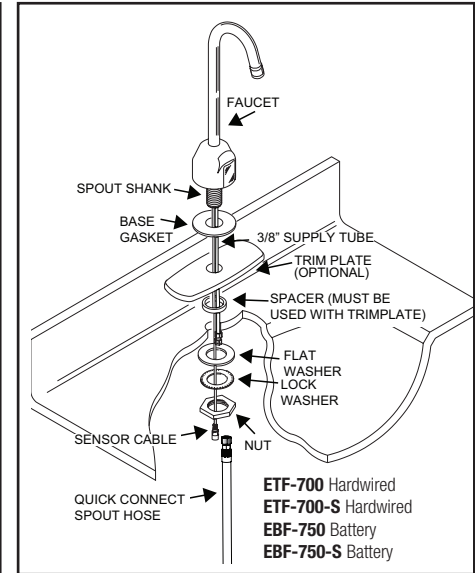
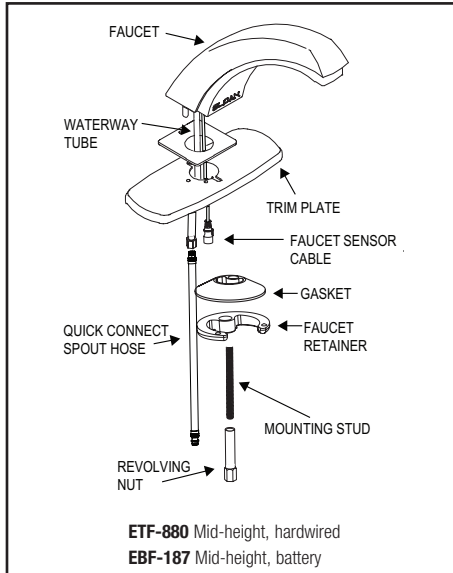
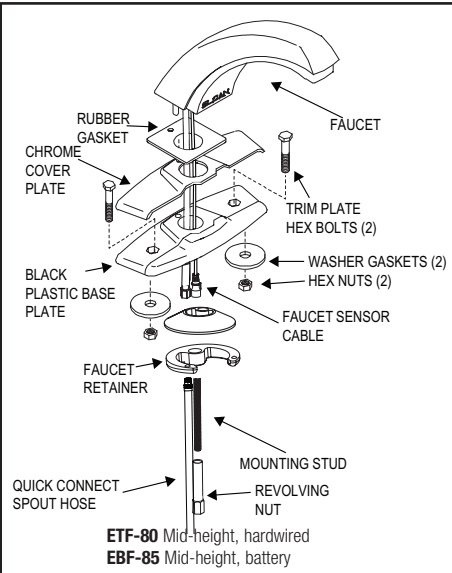
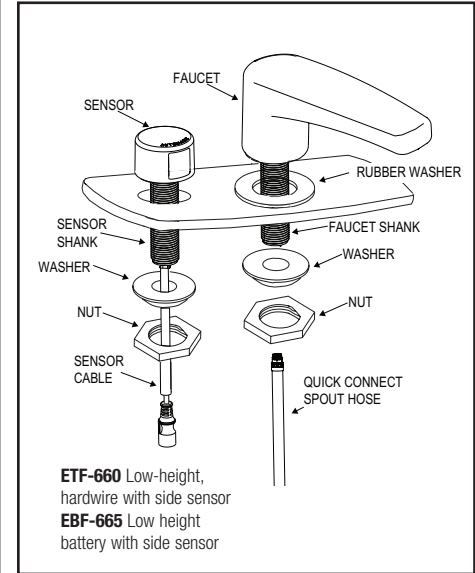
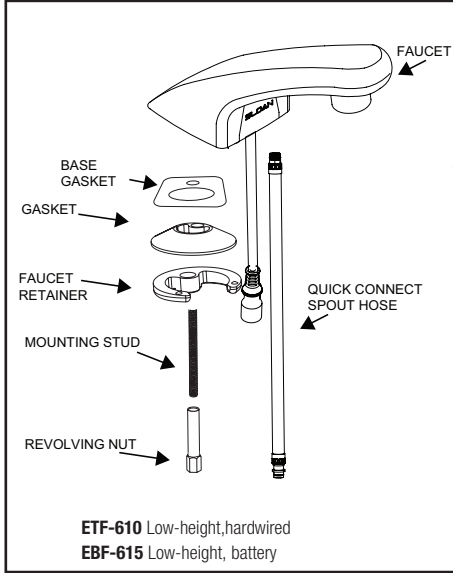
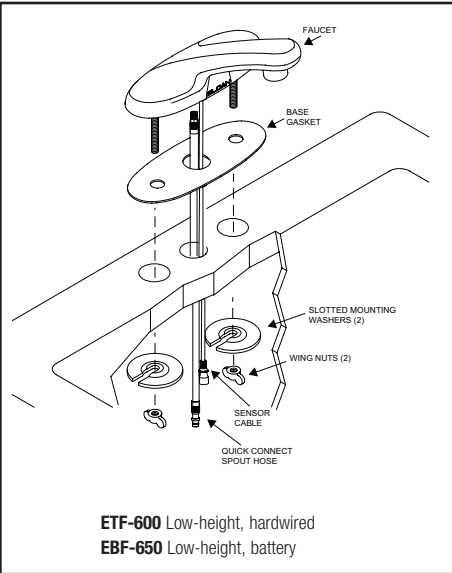

# DECK MOUNTED INSTALLATIONS

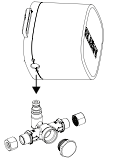
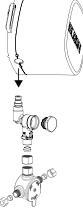
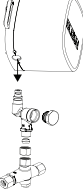

### BELOW DECK CONTROL ROUGH-IN DIMENSIONS

OPTIMA CONTROL BOX	MODEL IMAGE	HEIGHT	WIDTH	DEPTH
OPTIMA CONTROL BOX		5" (127 mm)	6" (163 mm)	4 1/2" (115 mm)
OPTIMA CONTROL BOX WITH DOUBLE INLET FILTER TEE		6 1/4" (159 mm)	6" (153 mm)	4 1/2" (115 mm)
OPTIMA CONTROL BOX WITH SINGLE INLET FILTER TEE AND BDM (MIX60)		10 1/8" (258 mm)	6" (153 mm)	4 1/2" (115 mm)
OPTIMA CONTROL BOX WITH SINGLE INLET FILTER TEE AND BDT (MIX135)		10 3/4" (274 mm)	6" (153 mm)	4 1/2" (115 mm)

### QUICK CONNECT HOSE/SENSOR CABLE LENGTHS

	QUICK CONNECT SPOUT HOSE LENGTH	SENSOR CABLE LENGTH
		
DECK MOUNTED MODELS	24" (610 mm)	28" (711 mm)
WALL MOUNTED MODELS	36" (914 mm)	36" (914 mm)

### DECK MOUNTED FAUCET MODEL ROUGH-IN DIMENSIONS (WITHOUT TRIMPLATE)

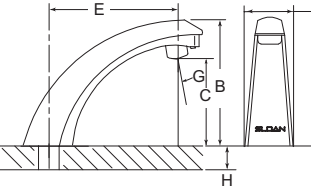
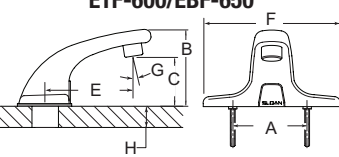
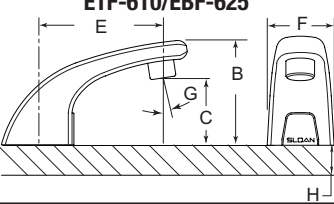
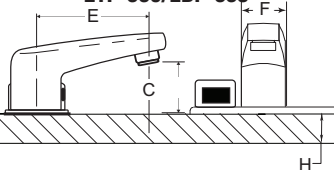
FAUCET MODEL	A	B	C	D	E	F	G	H
	MOUNTING	HEIGHT 1 (DECK TO TOP OF SPOUT)	HEIGHT 1 (DECK TO CENTER OF SPRAYHEAD)	PROJECTION 1 (CENTERLINE OF FAUCET TO END OF SPOUT)	PROJECTION 2 (CENTERLINE OF FAUCET TO CENTER OF SPRAYHEAD)	WIDTH (OF FAUCET)	SPRAY ANGLE (DEGREES)	MAX. DECK THICKNESS
 <p>ETF-80/EBF-85 ETF-880/EBF-187</p>	Single Hole	5 3/4" (146 mm)	4 1/4" (108 mm)	6 1/2" (165 mm)	5 1/8" (130 mm)	2" (51 mm)	12°	1 1/2" (38 mm)
 <p>ETF-600/EBF-650</p>	4" Centerset	3 5/8" (92 mm)	2 3/16" (56 mm)	4 1/2" (114 mm)	4 1/2" (114 mm)	6 5/16" (160 mm)	12°	3/4" (19 mm)
 <p>ETF-610/EBF-625</p>	Single	3 1/2" (89 mm)	2 1/12" (64 mm)	4 1/2" (114 mm)	4 1/2" (114 mm)	2 3/16" (56 mm)	12°	3/4" (19 mm)
 <p>ETF-660/EBF-665</p>	4" Centerset	3 3/4" (95 mm)	2 1/4" (57 mm)	5 1/4" (133 mm)	5 1/4" (133 mm)	1 1/2" (38 mm)	6°	3/4" (19 mm)

**GOOSENECK DECK MOUNTED / WALL MOUNTED FAUCET MODEL ROUGH-IN DIMENSIONS WITHOUT TRIMPLATE**

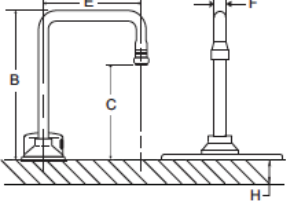
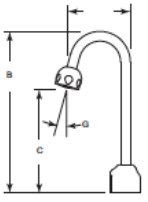
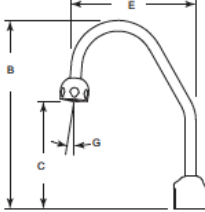
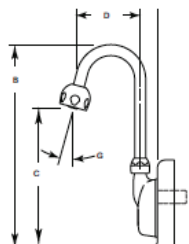
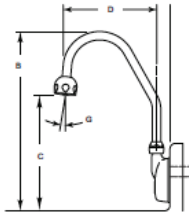
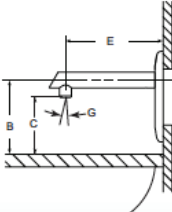
	<b>A</b>	<b>B</b>	<b>C</b>	<b>D</b>	<b>E</b>	<b>F</b>	<b>G</b>	<b>H</b>
<b>FAUCET MODEL</b>	<b>MOUNTING</b>	<b>HEIGHT 1 (DECK TO TOP OF SPOUT)</b>	<b>HEIGHT 1 (DECK TO CENTER OF SPRAYHEAD)</b>	<b>PROJECTION 1 (CENTERLINE OF FAUCET TO END OF SPOUT)</b>	<b>PROJECTION 2 (CENTERLINE OF FAUCET TO CENTER OF SPRAYHEAD)</b>	<b>WIDTH (OF FAUCET)</b>	<b>SPRAY ANGLE (DEGREES)</b>	<b>MAX. DECK THICKNESS</b>
<b>ETF-770</b> <b>EBF-775</b> 	4" Centerset	9-3/4" (248 mm)	5-1/2" (140 mm)	6-1/8" (156 mm)	5-1/2" (140 mm)	1" (25 mm)	0°	1-1/2" (38 mm)
<b>ETF-700 / EBF-750</b> 	Single Hole	10-1/4" (260 mm)	6-1/4" (159 mm)	5-1/4" (133 mm)	4-1/2" (115 mm)	0.5" (13 mm)	15°	1-1/2" (38 mm)
<b>ETF-700-S / EBF-750-S</b> 	Single Hole	12-1/4" (311 mm)	6-7/8" (175 mm)	9-1/2" (241 mm)	8-7/16" (215 mm)	0.5" (13 mm)	5°	1-1/2" (38 mm)
<b>ETF-500 / EBF-550</b> 	1" (25 mm) Diameter Hole Required	N/A	6-1/8" (156 mm)	4-9/16" (116 mm)	4-1/4" (108 mm)	0.5" (13 mm)	15°	N/A
<b>ETF-500-S / EBF-550-S</b> 	1" (25 mm) Diameter Hole Required	N/A	6-3/4" (171 mm)	8-3/16" (208 mm)	7-1/8" (156 mm)	0.5" (13 mm)	5°	N/A
<b>ETF-800 / EBF-850</b> 	4" Electrical Box & Plaster Ring or 2 1/2" Hole for Mounting bracket	N/A	6-23/32" (170 mm)	6" (152 mm)	7-1/8" (156 mm)	1" (25 mm)	0°	N/A

## TROUBLESHOOTING INSTRUCTIONS

**NOTE:** To automatically check battery strength, troubleshoot, diagnose and report faucet issues with a wireless device, use the Sloan SmartPhone APP. The APP is available free-of-charge at the Apple iPhone APP store for iOS devices or the Google Play APP store for Android devices. For more information about the APP and its capabilities please visit [www.Sloan.com](http://www.Sloan.com).

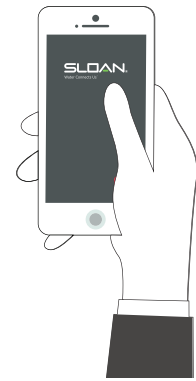

### LED indicator light in the IR (infrared) sensor is red.

A. Battery power is low.

Install four (4) new AA sized alkaline batteries. Check that the orientation of each battery matches the positive (+) and negative (-) symbols shown in the bottom of the battery compartment.

Re-attach battery compartment to control module. Green LED will illuminate. If the Green LED does not illuminate, remove battery compartment for 10 seconds and return into place.

### Faucet DOES NOT function.

A. Batteries not installed or are exhausted.

Install four (4) AA sized alkaline batteries. Check that the orientation of each battery matches the positive (+) and negative (-) symbols shown in the bottom of the battery compartment. Reattach battery compartment to control module. Green LED will illuminate. If the Green LED does not illuminate, remove battery compartment for 10 seconds and return into place.

B. Power Cable not installed (Hardwire models).

Install power cable and check connection.

C. Sensor Cable not installed.

Install sensor cable and check connection. Confirm connection guide markings are aligned.

D. Sensor range is set too short and is not detecting the target.

Increase sensor detection range.

### Sensor is activated but faucet DOES NOT deliver water.

A. Faucet has initiated its adaptive sensing calibration program.

Wait 60 seconds before activating faucet.

B. Solenoid Cable not connected.

Check solenoid cable connection. Confirm connection guide markings are aligned.

### Sensor Range Requires Manual Adjustment.

Sensor Range is measured in units from 1 to 5, with 1 being closest to the faucet and 5 being farthest from the faucet. The factory default Sensor Range is 3.

A. To determine what the current Sensor Range setting is, press the red "Sensor" button on the upper right hand corner of the Optima Control Box for 1 second. Five seconds after pressing the button, the green LED beside it will blink to indicate the Sensor Range setting. For example, if it is set at 2, the green LED will blink 2 times.

B. To adjust the Sensor Range, press and hold the red "Sensor" button for three seconds and release once the green LED comes on to indicate that you are in Sensor Range adjustment mode. Then press the "Sensor" button one second at a time for however many times you wish to increase the range. For example, if the Sensor Range is set at 2 and you wish to increase it to 4, press the "Sensor" button two times for one second each time..

C. If you wish to decrease the Sensor Range, follow the same procedure to enter into Sensor Range adjustment mode, and then press the "Sensor" button one second at a time. The button is designed to go up to 5 units and then back down to 1 unit. For example, if the Sensor Range is set at 4 and you wish to decrease it to 2, press the "Sensor" button three times for one second each time.

D. To conform your changes, wait 5 seconds and then press the red "Sensor" button on the upper right hand corner of the Optima Control Box for 1 second. Five seconds after pressing the button, the green LED beside it will blink to indicate the Sensor Range setting. For example, if it is now set at 2, the green LED will blink 2 times.

### Solenoid produces an audible "CLICK" when an object is placed in the detection zone of the sensor but NO water flows.

A. Water supply to faucet is not open.

Open supply stop(s).

B. Inlet fitting filter is clogged.

Remove, clean, and reinsert. Replace with EBF1004 solenoid filter kit if necessary.

C. Aerator or spray head is clogged.

Remove, clean, and reinsert.

### Solenoid valve DOES NOT produce an audible "CLICK" and NO water flows. Green LED illuminates when batteries installed.

A. Solenoid valve module is not working properly.

Replace EFP43A solenoid valve module.

## TROUBLESHOOTING INSTRUCTIONS (CONT.)

### Faucet delivers only a slow flow or dribble when sensor is activated.

- A. Water supply valve is partially closed.  
Open the supply stop(s) completely.
- B. Inlet fitting filter is clogged.  
Remove, clean, and reinsert. Replace with EBF1004 solenoid filter kit if necessary
- C. Aerator or spray head is clogged.  
Remove, clean, and reinsert.

### Faucet DOES NOT stop delivering water or continues to drip after user is no longer detected (automatic shut-off fails even when batteries are removed).

- A. Solenoid valve seat is dirty.  
Remove, clean, and reinsert solenoid filter. Activate faucet several times to flush out dirt.
- B. Sensor range is set too long and is detecting the sink or some other object.  
Reduce sensor detection range.
- C. Solenoid valve module is not working properly.  
Replace EFP43A solenoid valve module.

### The water temperature is too hot or too cold on a faucet connected to hot and cold supply lines with inlet filter fitting.

- A. Supply stops are not adjusted properly.  
Adjust supply stops.

**NOTE: For some systems, a thermostatic mixing valve may be required**

## CARE AND CLEANING INSTRUCTIONS

DO NOT USE abrasive or chemical cleaners (including chlorine bleach) to clean faucet that may dull the luster and attack the chrome or special decorative finishes. Use ONLY mild soap and water, then wipe dry with clean cloth or towel. While cleaning the bathroom tile, protect the faucet from any splattering of cleaner. Acids and cleaning fluids will discolor or remove chrome plating.



## FCC INFORMATION TO USERS

This equipment has been tested and found to comply with the limits for a class B digital devices, pursuant to Part 15 of the FCC Rules. These limits are designed to provide reasonable protection against harmful interference in a residential installation. This equipment generates, uses, and can radiate radio frequency energy and, if not installed and used in accordance with the instruction manual, may cause harmful interference to radio or television reception, which can be determined by turning the equipment off and on, the user is encouraged to try to correct the interference by one or more of the following measures:

- Reorient or relocate the receiving antenna
- Increase the separation between the equipment and receiver
- Connect the equipment into an outlet on a circuit different from that to which the receiver is connected
- Consult the dealer or an experienced radio/TV technician for help

**If further assistance is required, please contact Sloan Tech Support  
at 1-888-SLOAN-14 (1-888-756-2614)**

**SLOAN • 10500 SEYMOUR AVENUE • FRANKLIN PARK, IL 60131**

Phone: 1-800-982-5839 or 1-847-671-4300 • Fax: 1-800-447-8329 or 1-847-671-4380 • [www.sloan.com](http://www.sloan.com)



Water Connects Us®

## SLOAN DECK MOUNTED SOAP DISPENSER (ESD-SERIES) INSTALLATION INSTRUCTIONS



### Touchfree Counter Mounted System Installation Guide

If there is a dispenser currently installed

- Remove the existing unit, both the above and below counter assemblies
- Clean the counter area where the previous dispenser was located
- Verify the size of the existing counter hole is 15/16" to 1-1/4" in diameter

If there is no hole in the counter

- Prior to drilling, examine below the counter to ensure adequate clearance for the new unit
- Drill a 1" diameter hole in the counter top
- The hole can be drilled to either the right or left of the faucet, ensuring adequate clearance for the below counter assembly
- Clean the counter area where the new hole is located

### Prior To Installation

New Soap Dispenser Installation:

- Ensure that dispenser does not interfere with anything above or below the lavatory/counter top area
- Drill a 1" diameter hole in counter top
- Clean area around hole

### To Order Replacement Soap Cartridges

800.321.9647

GOJO Industries

Refills are also available through your local plumbing or janitorial supply distributor.

When the soap bottle is empty, a new bottle must be used. The bottle furnished with the unit is not designed to be refilled. Altering the bottle and refilling it with soap will void the warranty of the product.



Improper installation of the Counter Mounted Dispenser could result in breakage.

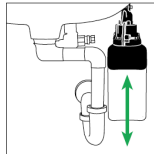

Proper installation allows the unit to vertically hang beneath the sink.

Dispenser must hang freely underneath the sink.

### LIMITED WARRANTY

Unless otherwise noted, Sloan Valve Company warrants its Products to be made of first class materials, free from defects of material or workmanship under normal use and to perform the service for which they are intended in a thoroughly reliable and efficient manner when properly installed and serviced, for a period of three years (1 year for SF Faucets, special finishes and PWT electronics and 30 days on PWT software) from date of purchase. During this period, Sloan Valve Company will, at its option, repair or replace any part or parts which prove to be thus defective if returned to Sloan Valve Company, at customer's cost, and this shall be the sole remedy available under this warranty. No claims will be allowed for labor, transportation or other incidental costs. This warranty extends only to persons or organizations who purchase Sloan Valve Company's products directly from Sloan Valve Company for purpose of resale. This warranty does not cover the life of the batteries.

**THERE ARE NO WARRANTIES WHICH EXTEND BEYOND THE DESCRIPTION ON THE FACE HEREOF. IN NO EVENT IS SLOAN VALVE COMPANY RESPONSIBLE FOR ANY CONSEQUENTIAL DAMAGES OF ANY MEASURE WHATSOEVER.**

**SLOAN • 10500 SEYMOUR AVENUE • FRANKLIN PARK, IL 60131**

Phone: 1-800-9-VALVE-9 or 1-847-671-4300 • Fax: 1-800-447-8329 or 1-847-671-4380 • [www.sloan.com](http://www.sloan.com)

# Soap Dispenser Installation

**NOTE: ESD-2100 Shown, instructions applicable for all Sloan soap dispensers**

## Installing the Touchfree Counter Mounted System

Prior to beginning installation, study the exploded view of the Touchfree Counter-Mounted System and locate all the pieces. Also, look beneath the countertop to a suitable place for mounting of the Battery Box (9) so that it will not interfere with system components or plumbing.

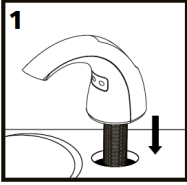

Feed the Data Cable 5a and the shank of the Dispenser Assembly 1 through the hole in the countertop. Point the spout of the Dispenser into the sink bowl.

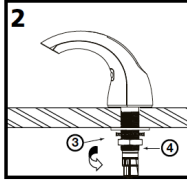

From underneath the counter, feed the Lock Washer 3 and then the Mounting Nut 3a over the Data Cable 5a and onto the threaded shank of the Dispenser Assembly 1. Tighten the nut securely.

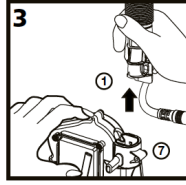

Align the indent inside the top of the Motor Assembly/Bottle Support 7 with the indent on the shank of the Dispenser Assembly 1 and firmly push the Motor Assembly/Bottle Support up, onto the shank.

**NOTE:** Hold the Data Cable firmly out of the way as you push up on the Motor Assembly/Bottle Support. Continue pushing upward until the vertical slots in the Dispenser shank and the Motor Assembly/Bottle Support line up.

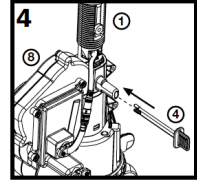

Secure the Motor Assembly/Bottle Support 7 to the Dispenser Assembly 1 shank by pushing the Retaining Clip 4 into place through the vertical slots, until it goes all the way through the Motor Assembly.

**NOTE:** Motor Assembly Bottle Support will rotate 360° to avoid any obstruction.

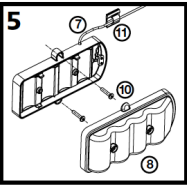

Remove the cover from the Battery Box 8 by loosening the two captive screws on the Battery Box cover. Position the Box on a convenient (vertical or horizontal) surface under the counter top that will allow access for battery changing. Attach the Box to the surface using the two screws 10 and anchors (if attaching to a plaster or masonry surface). Use the Wall Clip 11 to secure the Power Cable to a wall or other under-counter surface if desired.

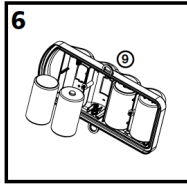

Place four alkaline "D" Cell batteries into the Battery Box 9 cover. The batteries must be positioned according to the diagrams shown on the inside of the cover.

**NOTE:** If the batteries are not properly installed or the cover is not properly positioned on the Box, the System will not work. Position the cover (with batteries installed) on the Battery Box and tighten the two captive screws.

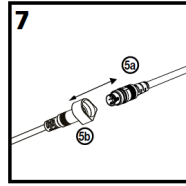

**IMPORTANT:** Connect the two halves of the Data Cable 5a and 5b by visually lining up the white stripes on each half and gently pushing the cable connectors together until the stripes touch.

**Improperly assembled connectors can cause unit to not function as intended.**

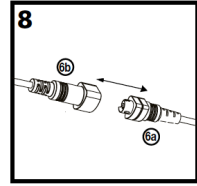

After the batteries are installed in the battery box, connect the two halves of the power cable 6a and 6b. Allow 20 seconds before the system is ready to dispense soap.

# Soap Refill Bottle Installation and Removal

## Refill Installation

(refill 9 sold separately)

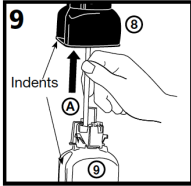

Feed the dispense tube A on the Refill Bottle 9 up through the Motor Assembly/Bottle Support 7 and Dispenser Assembly 1, aligning the two indents in the Bottle and the Support. Slide the Bottle upward until it snaps into place.

**NOTE:** The refill is not properly installed until you hear the "snap" (as the Green release latch on the Motor Assembly/Bottle Support 7 engages).

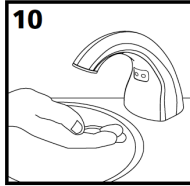

Test the System by passing your hand under the spout of the Dispenser Assembly 1 (in front of the sensor window) at least three or four times, until foam soap appears. If the System does not dispense soap after passing your hand in front of the sensor several times, repeat several more times. If no sound heard from motor assembly after placing hands in front of sensor, check to see that the Data Cable 6 halves are firmly connected, that the batteries are "good", and that the Battery Box 8 cover is properly positioned and fastened to the Box. Check for bent contact pins inside connector 6b. If unit is multi-activating, check for bent contact pins inside connector 6b.

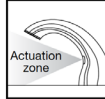

## Refill Removal

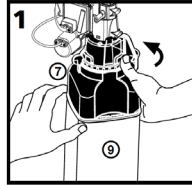

Grasp the empty Refill Bottle 9 with one hand and use the other hand to push the Green release latch on the Motor Assembly/Bottle Support 7 to the right (counterclockwise as seen from above).

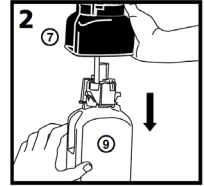

Grasp the empty Refill Bottle 9 with one hand and use the other hand to push the Green release latch on the Motor Assembly/Bottle Support 7 to the right (counterclockwise as seen from above).

### Cleaning the Counter Mounted System

Use only mild soap and water to clean the Touchfree Counter Mounted System spout. Cover the sensor window with your thumb while cleaning the spout so that you do not continue to dispense soap.

**DO NOT** use abrasives to clean the TouchFree Counter-Mounted System (as this may damage the finish or the sensor window).

## Soap Replacement

To order replacement soap cartridges:  
CONTACT **GOJO** Industries at 800.321.9647  
Available refills

ESD-321 8565-02-N6300GN: 1500 ml Green Certified Foam Refill (2 Pack)

ESD-322 8545-04-N6300GN: 2300 ml Green Certified Foam Refill (4 Pack)

**ATTENTION:** do not handle by tube. For proper operation, ensure that tubing is not loose or bent.

# Parts Breakdown

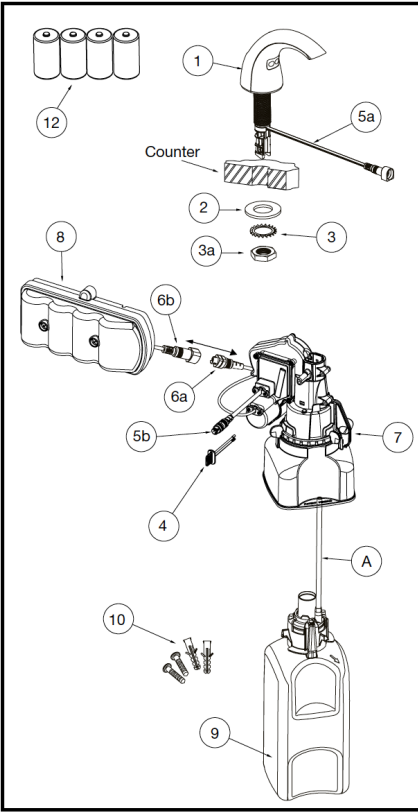

ITEM	DESCRIPTION	QTY.
1	DISPENSER ASSEMBLY	1
2	FLAT WASHER	1
3	LOCK WASHER	
3a	HEX NUT	1
4	RETAINING CLIP	1
5	DATA CABLE (2 HALVES WITH CONNECTOR - a and b)	1
6	POWER CABLE (2 HALVES WITH CONNECTOR - a and b)	1
7	MOTOR ASSEMBLY/BOTTLE SUPPORT	1
8	BATTERY BOX (USES 4 "D" CELL BATTERIES PROVIDED)	1
9	REFILL BOTTLE (SOLD SEPARATELY)	1
10	SCREWS & ANCHORS FOR BATTERY BOX MOUNTING	2 EA.
11	WALL CLIP FOR POWER CABLE	1
12	"D" CELL BATTERIES (PROVIDED)	4

**SLOAN • 10500 SEYMOUR AVENUE • FRANKLIN PARK, IL 60131**

Phone: 1-800-9-VALVE-9 or 1-847-671-4300 • Fax: 1-800-447-8329 or 1-847-671-4380 • [www.sloan.com](http://www.sloan.com)